

TOP VIEW

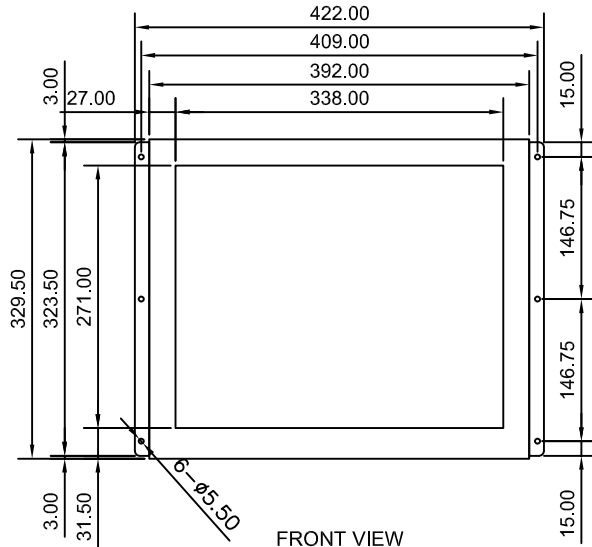

FRONT VIEW

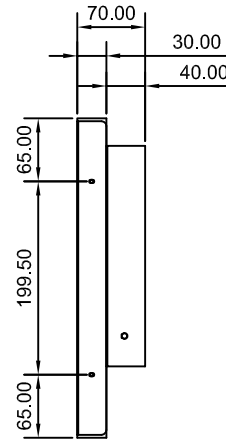

SIDE VIEW

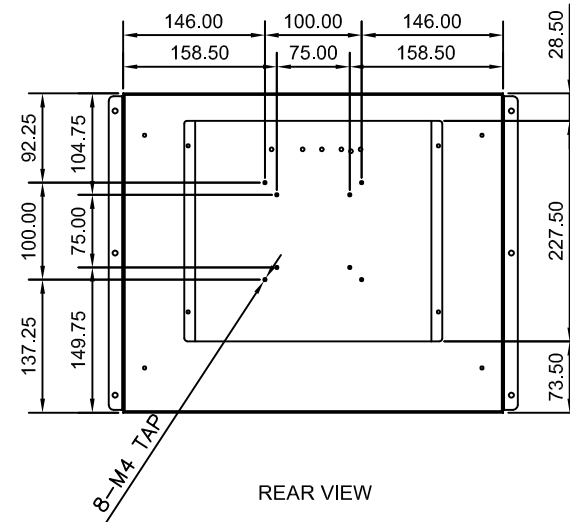

REAR VIEW

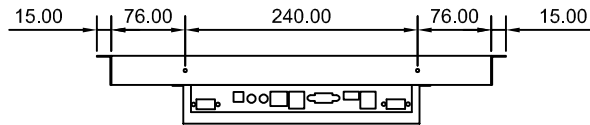

BOTTOM VIEW

SPECIFICATION

DIMENSION	392mm*329.5mm*70mm
THICKNESS	
MATERIAL	STEEL
PAINTING	BLACK

CUSTOMER



KOREA COMPUTER
& COMMUNICATION

△		-	-	-	
NO.	DATE	DESCRIPTION	DRN	CK	APPR

PROJECT IDVLV2-170

REV.	SCALE	SHEET NO.	TITLE	IDVLV2-170 ASSY
0	1:1	01/01	DRAWING NO.	IDVLV2-X-170-X
				SIZE : A4